



PET Preform System

Simple Solution



PET Preform System

Based on its technology strength and experience in auxiliary equipment field, Shini can meet various kinds of demands from plastics conveying, dehumidifying and drying; mould heating and cooling; regrinds recycling to color management. Adopt intelligent energy-saving control technology to monitor the material processing. Shini can provide different solutions according to different requirements from the customers.

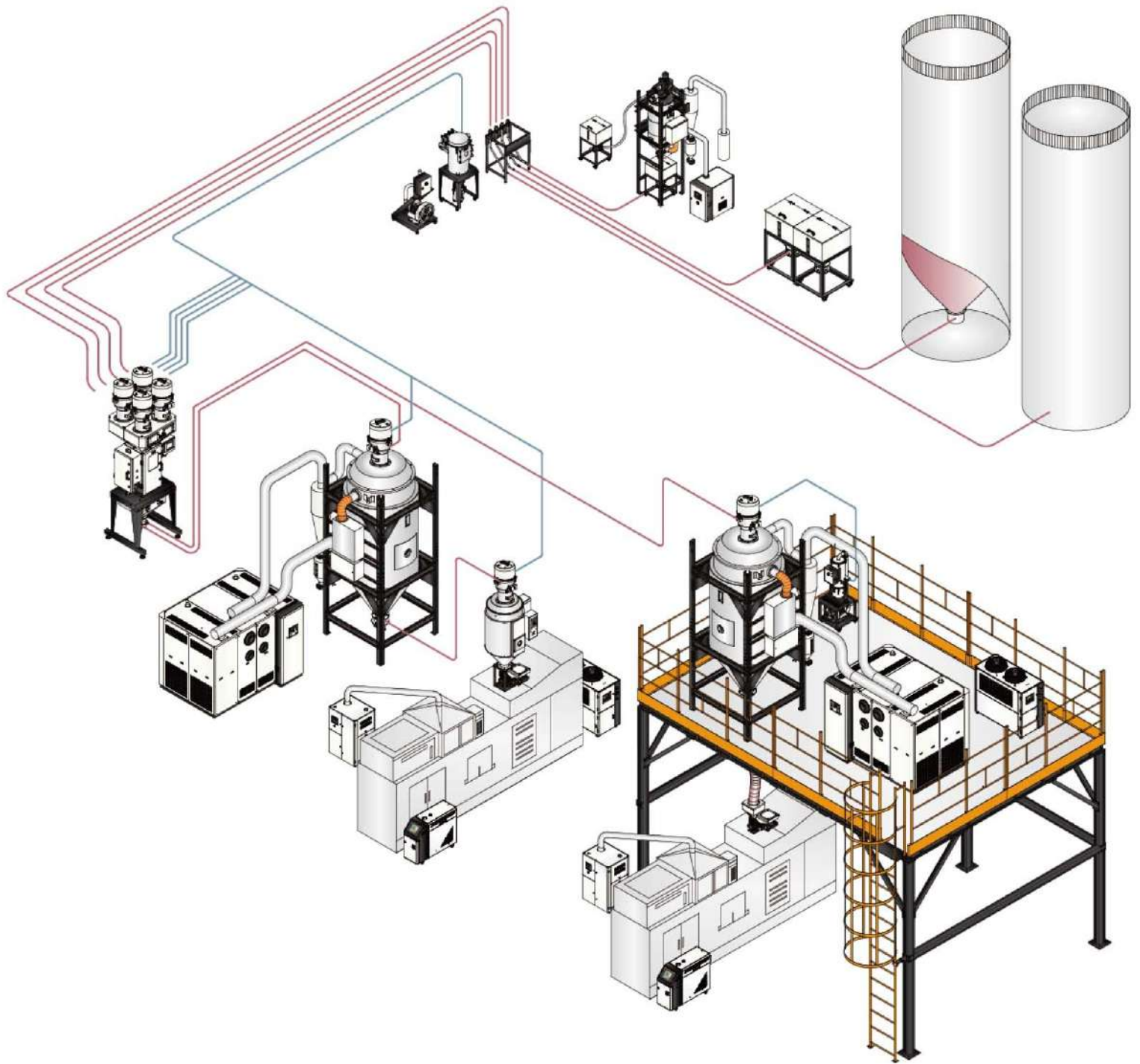

PET Preform System

Auto Conveying & Feeding System

Shini specially designed auto conveying and feeding system for PET processing. The outdoor positive pressure conveying system consists of outdoor material silo, material discharge terminal, vacuum pump, rotary valve assembly and material distribution station, etc. And the indoor feeding system is made up of different hopper loaders and hoppers with conveying capacity of 2,000kg/hr and conveying distance of 100m.

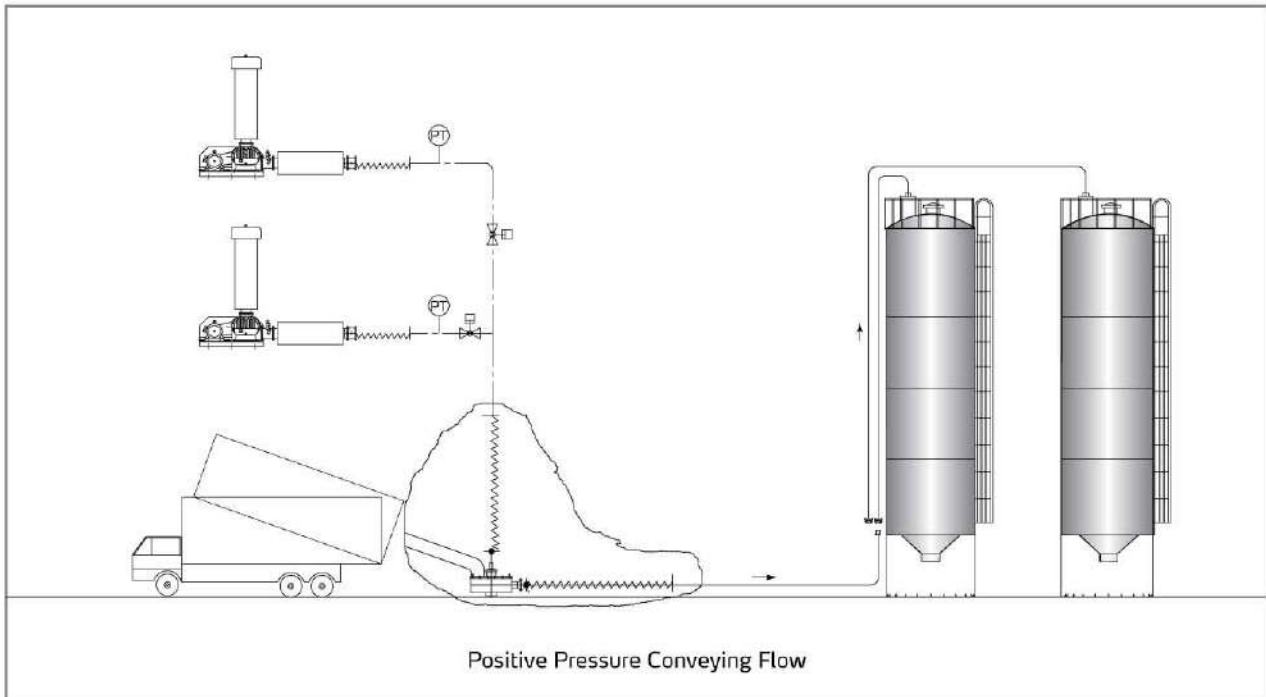

- Claw pumps and compressors generate contact-free vacuum or compressed air efficiently and economically. This is possible because of the principle of internal compression. The gas is pre-compressed within the compressing chamber and is then discharged. This leads to an evident energy saving compared to rotary lobe blower designs without internal compression.

- Dry, contact-free operation
- Process safe and reliable
- No oil in the compression chamber
- Frequency control available
- Low sound level
- No greasing of bearings

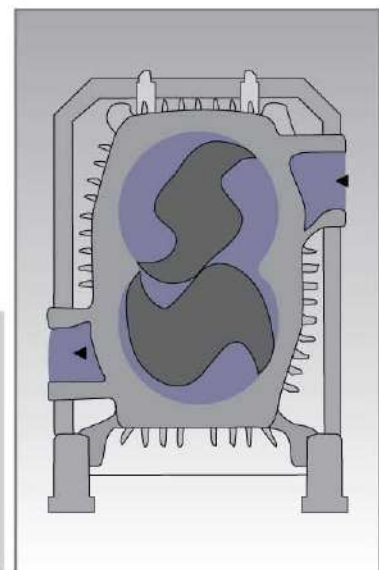



- All material contact surfaces and filter device of the system are made of stainless steel ensures no contamination during PET material conveying.
- By adjusting conveying speed, the flexible air refilling adjusting system can avoid stringing and dusting caused by different conveying situations.



With Cooling Device



With Pressure Difference Detection Device

- For high temperature conveying of PET, Shini specially came up with the solution with water-cooling function which decrease the risk of high temperature material conveying.
- Closed loop of two-stage conveying system. For the conveying of materials to the hopper on injection molding machine, Shini can greatly reduce the heat dissipation and the risk of material rewetting.
- Filter pressure difference detector is adopted on the vacuum pump of the hopper loader to ensure timely cleaning and protection

PET Preform System

■ Drying System

In PET preform system, drying becomes the most critical step which must be seriously taken and the moisture in the material must be removed at a reasonable temperature.

Shini dehumidifying dryer can provide dew-point of -40°C or even lower. Also it can achieve constant detection of all the parameters and stabilize the dew-point.

Adopt heat exchanger to realize heat recycling with which 20% energy can be saved.

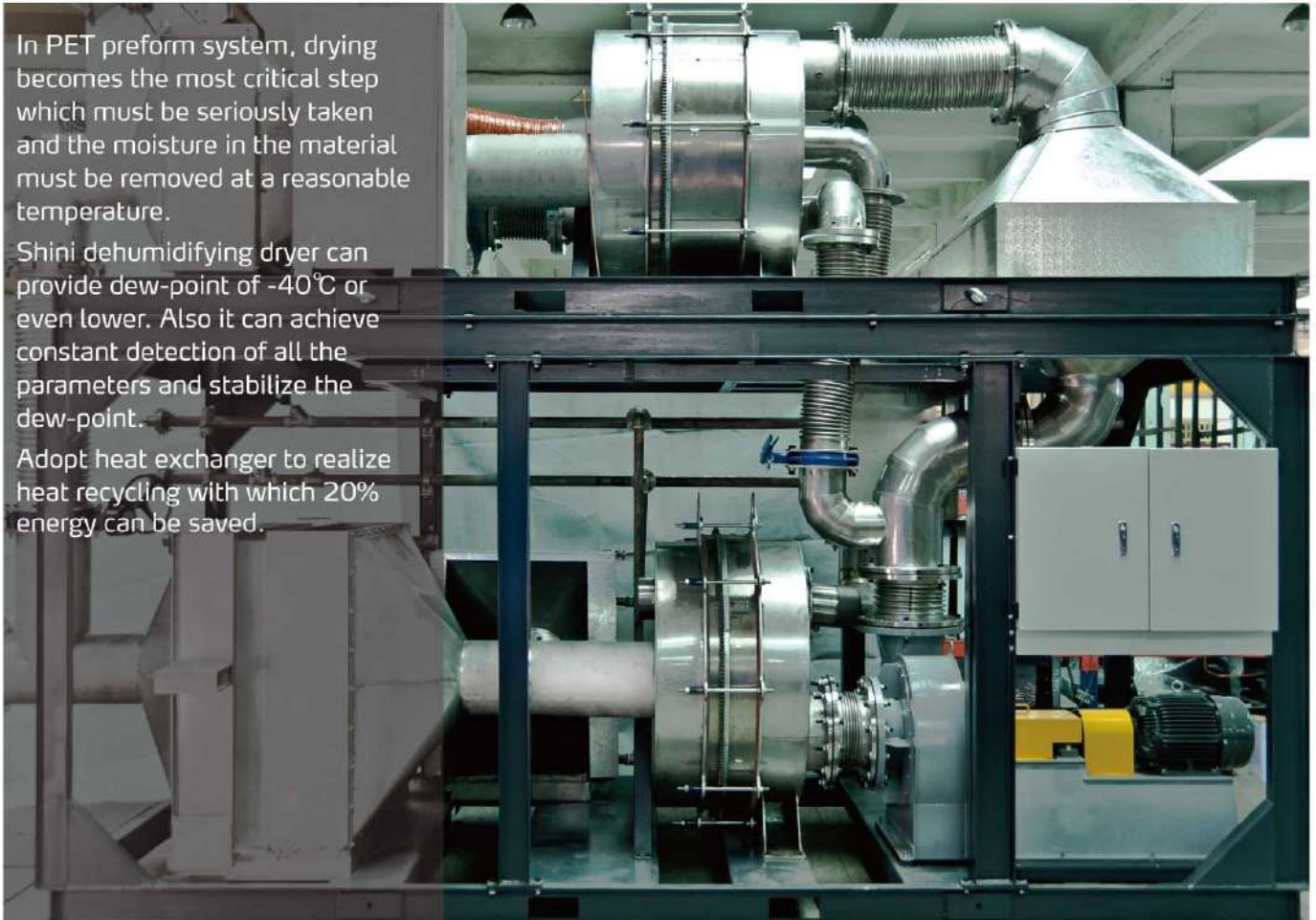

- Control system, adopting frequency control technology, will automatically adjust the air volume to optimize the working condition of the drying hopper to achieve the optimal drying effect. The reduce of air volume will lead to power reduction of drying heater, then a 20% energy consumption can be avoided.
- Dew-point of traditional dehumidifiers can not be set and the machines are working full-loaded. However, the humidity requirements of PET material processing are always rigorous. Therefore, the dew-point must be set and controlled properly. Differ from traditional dehumidifier, the new Shini model combines the settable dew-point together with the regenerating control greatly saves the energy.
- Adopt heat exchanger to realize heat recycling. The hot air exhausts from the drying hopper goes through the cyclone dust collector and then enters heat exchanger to exchange heat through which on the one hand decrease the return air temperature, and on the other hand save the heat which preheats the air entering into the drying hopper and saves energy at 20%.

- Drying hopper adopts stainless steel with heat-resistance layer thicker than 50mm. It is suitable for PET flakes and sheets. With capacities ranging from 1,500L to 8,000L, the hopper adopts special designed down-blowing air pipe to evenly spread the hot air to dry the materials.
- There applies pneumatic valve between material storage tank and the drying hopper to avoid heat dissipation and feeding troubles caused by high temperature.
- Cyclone filter is adopted on the return air loop to protect dust from going into the drying system, with which not only the product quality had been improved, but also the maintenance cost had been reduced.
- The particular guide plate design in the hopper can make material move fluently and dried thoroughly.
- Constant material level detection makes real-time monitoring of material level come true.

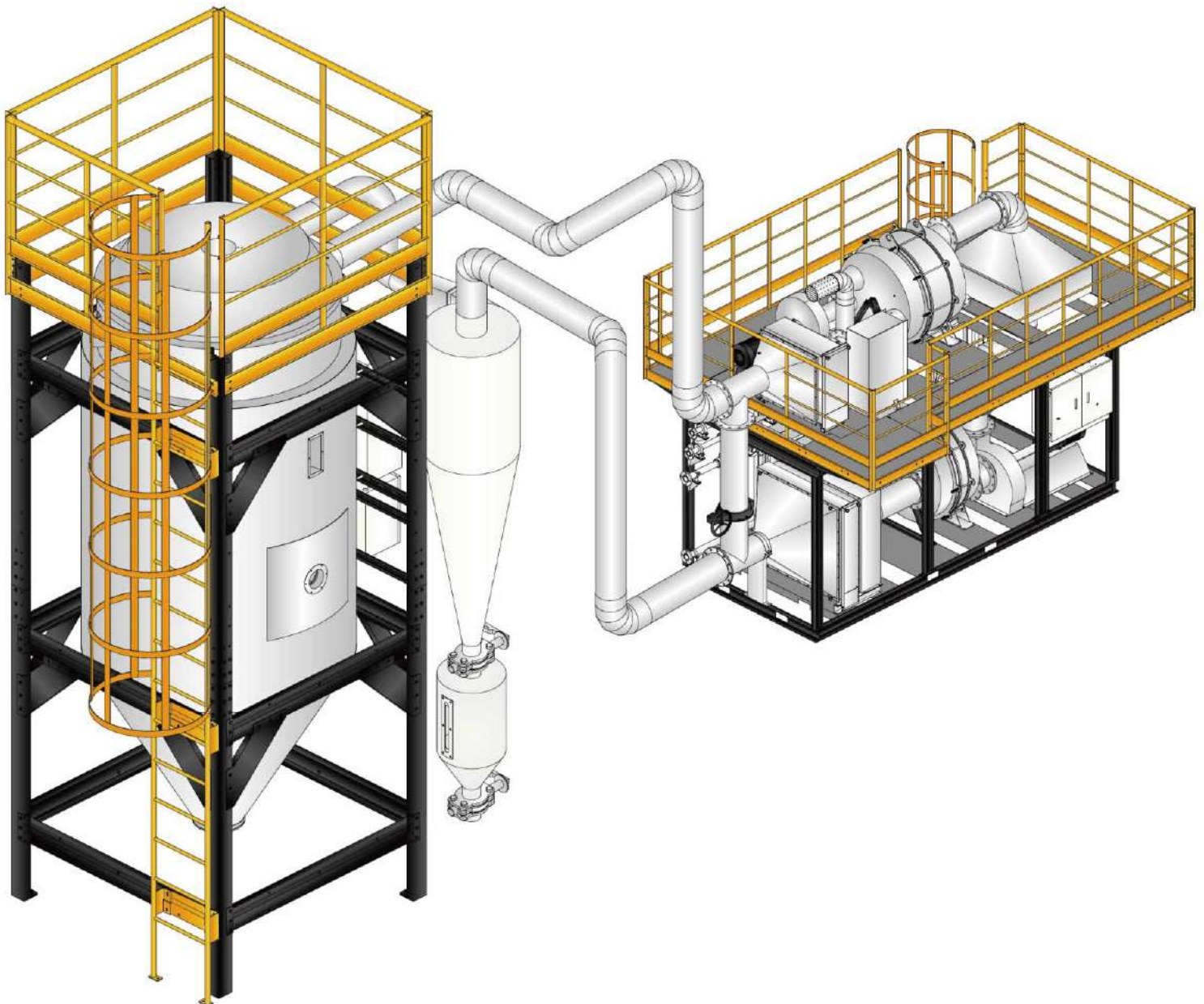

PET Preform System

■ Color Management System

SGD



SCM-H



SCM model of Shini is suitable for masterbatch particles both crystallized and non-crystallized with output within 0.2~32kg/hr. If the masterbatch proportion and precision is demanding, SGD model is suggested which adopts loss-in-weight calculation with output within 0.04~32kg/hr.

- Adopt brushless motor to accurately control the rotation frequency of the screw.
- The inner cooling water system can prevent masterbatch from falling into the PET main stream and melting. Thus ensures accurate dosage.
- Modular assembly structure with forced cleaning function makes masterbatch replacement much more convenient.
- Current running mode can be recorded which is free from power failure. When power comes back, the system can be resumed.
- Molding cycles of adding masterbatch can be set to meet the requirements of micro weight measuring.



Gravimetric Sensor



Gravimetric and loss-in-weight dosing system is applicable for precise dosing of granules and sheet materials with which product quality can be guaranteed.

- The output of Shini SGB is with 40~3,000kg/hr with 2~8 ingredients.
- With gravimetric sensor and material level switch, the special gravimetric blender designed for high temperature material is suitable for PET crystallized materials.
- Ethernet interface attached to the controller works together with the relevant software, material proportion data (max. output, actual output, proportioning accuracy) can be transmitted to control product quality.
- Recalibration will be automatically started after each weighing to ensure optimal proportion accuracy.
- Regrinds auto compensation function available. Aberration compensation can be automatically calculated based on the discharge amount of material.

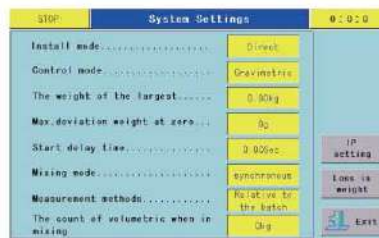

System Setting



Recipe Edit

- Special bridge-breaking structure and discharge way are used to meet all the requirement of sheet material dosing and at the same time ensure the continuity of the operation.

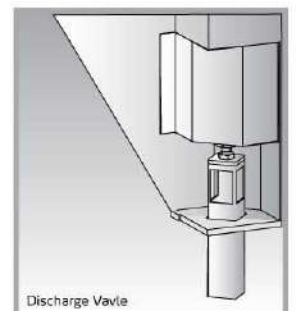

PET Preform System

■ PET Crystallizer

Shini PET crystallizer is specially designed for the homogeneous crystallization as well as overcoming glass transition temperature. Also it can avoid material bonding and bridging. With models from SCR-160U to SCR-2500U, the hopper capacity ranges from 160 to 2,500 liters.

The particular design of hopper bottom helps optimize the circulation of the hot air and ensures the maximum efficiency of energy exchange.



- The material level switch can help adjust the running mode of both the crystallizer and the feeding device based on the actual material level it detects.
- Adopt accurate temperature detection system and rotary valve equipped at the material discharge port to ensure constant crystallization and avoid material degradation.
- The hopper body is made of stainless steel and blender device is electroplated to protect material from being polluted.
- Easy cleaning. Big clearance door of the hopper can make cleaning and maintenance much more convenient. Also the cone part of the hopper can be separated from the main body for better maintenance.

■ Storage

For material storage, Shini can provide you large scale silos which are suitable for outdoor application, and small sized material tanks for regrinds and masterbatch materials. When container bags are used, Shini can also provide you relevant discharging and storage equipments.

Real-time monitoring of material level makes operation much more convenient.



PET Preform System

■ Recycling System



Shini granulators are applicable to granulating of all kinds of recycled plastic products such as pre-forms and PET bottles. They can help you regrind and recycle products efficiently and save energy.

- Centralized control design makes operation easier.
- Openable cutting chamber makes cleaning easier.
- Feed throat can be closed for safe operation.
- Multi-safety device ensures no damage to machine and operator.
- Adopts high pressure blower to convey material and make sure there is no remain in storage box and cutting chamber.
- Adopts cyclone dust-separator for removal of dust from regrind.



Paddle Blades



Staggered Blades

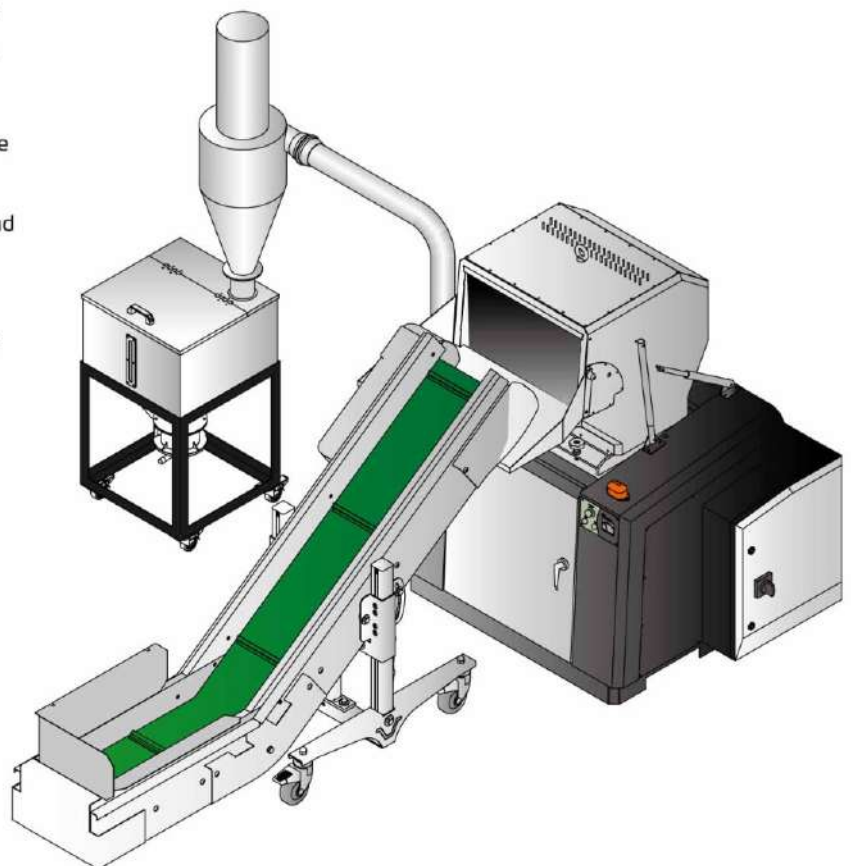

■ Metal-Detecting



- The PET regrinds is conveyed to the metal detecting separator to get purified and make sure there is no metal impurities in the material. Thus the screw of the injection molding machine will not be damaged.
- With output ranging from 600L/hr~3,000L/hr, metal detecting separator of Shini can detect metals with diameter of 0.5mm to the smallest.

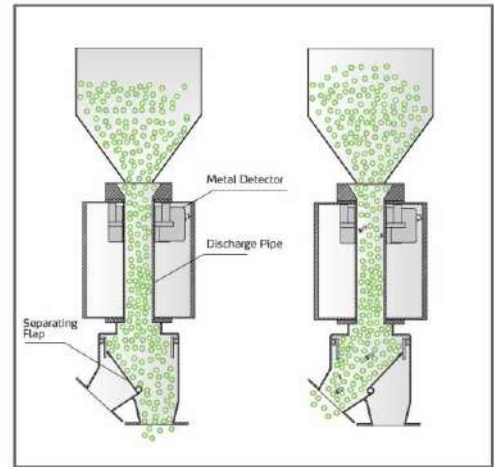

■ Mould Sweat Dehumidifying System

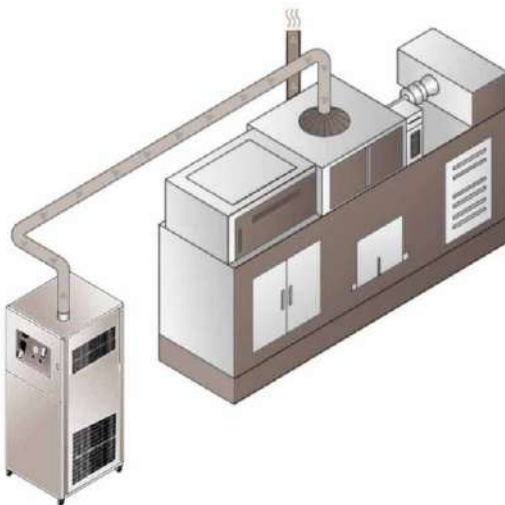

Open Type

- When mould surface temperature is lower than the surrounding air dew-point temperature, dew will emerge. The formation of dew will not only lead to poor product quality and reduction of productivity, also the mould surface can be corroded in succession pollute the environment. Shini mould dehumidifier can effectively solve the problem and ensure stable molding condition and maximum production capability of PET system.

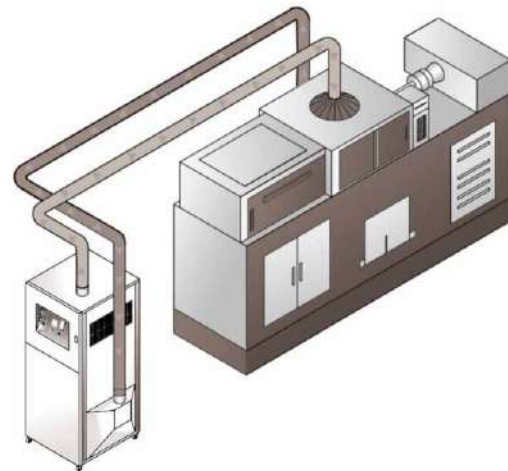

Hermetic Type

- Shini mold dehumidifier SMD adopts honeycomb rotary system to maintain a constant +5℃~-10℃ dew-point around the mould, leaves no chance for the mold to form dew in any season and greatly reduce the product defect ratio.

PET Preform System

■ Cooling System



SIIC Water Chiller



R410A Refrigerant Water Chiller

- The R410A model of Shini Chiller is a model which meets the high requirements from the world to protect the environment and does no harm to ozonosphere.
- The newly-launched SIIC adopts frequency converter compressor which can change frequency according to the load variation, to adjust refrigerating capacity and maintain a constant chilled water temperature. Compared with the traditional chiller, the new model can save energy at 15%.
- PVC pipe can be specially equipped in the chiller inside in case that the less-than-ideal local water quality may cause troubles to the system.
- The simple and reasonable water pipeline design and installation of the system can on one hand stabilize the operation, and on the other hand decrease the cost of the customer.

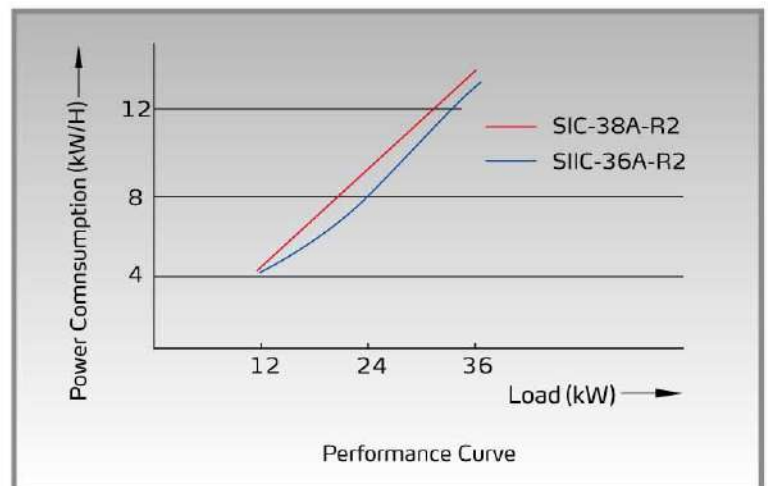

■ On-line PET Water Ratio Detection

- In PET molding production, water contains play a very important role in the production. To ensure high quality, the water ratio of the PET material must be controlled within the range permitted. AQU 100 water contain tester is dedicated to detect PET material.

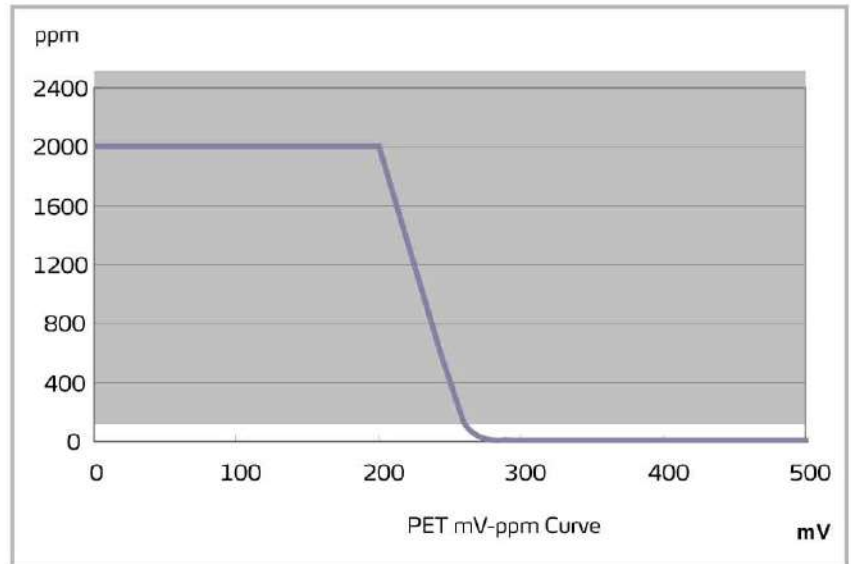

- By detecting the electrostatic pressure of PET material after drying, AQU 100 compares the present value to the PET mV-ppm curve and PET bulk specific weight input before detecting, thus the water contain can be obtained.
- The device is installed at the discharge port of the drying hopper, equipped with touch panel human-machine interface, real-time detection can be realized. With detection range of 10~1,000ppm, the accuracy can reach ± 1 ppm.



Shini Group

Addr: No. 23, Minhe St., Shulin Dist.,
New Taipei, Taiwan

Tel: +886 2 2680 9119

Fax: +886 2 2680 9229

Email: shini@shini.com

Factories:

- Taiwan
- Dongguan
- Pinghu
- Ningbo
- Mumbai

2013-04-15-04 Copyrights Reserved.

www.shini.com